



*Your Roof. For Life!
On Time and Complete!™*

PBR/R - Panel Flashings & Trims

PBR/R-Panel Flashings & Trims



RP01

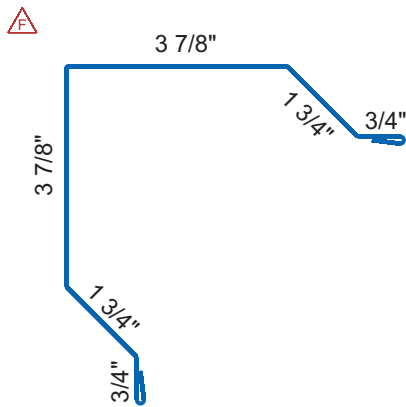

Outside Corner

RP02

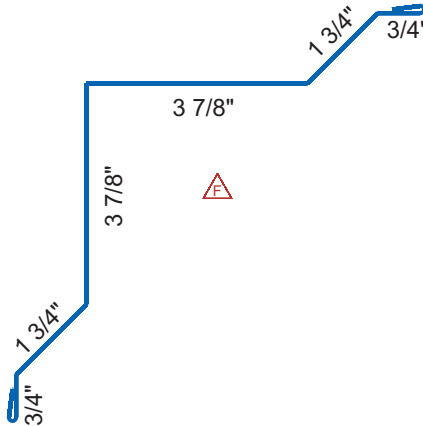

Inside Corner

RP03

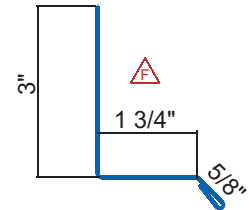

Base Angle

RP04

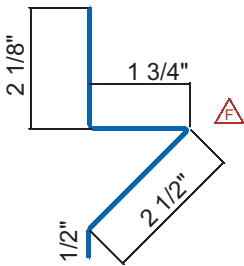

Base Trim

RP05

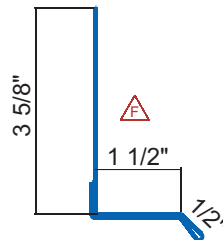

Head Trim (Sill)

RP06

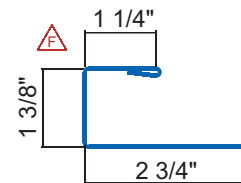

Head Trim (J-Channel)

RP07

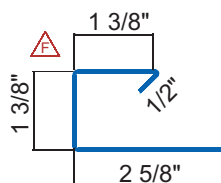

Jamb Trim

RP08

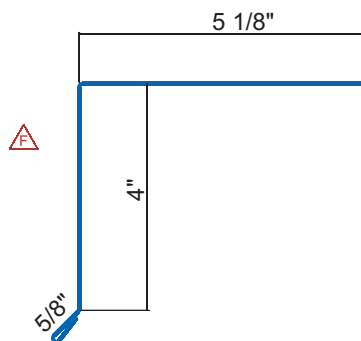

Eave Trim

RP09

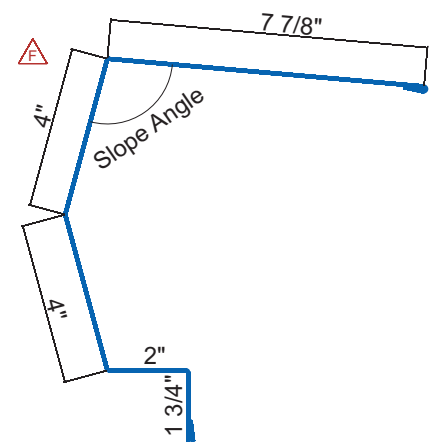

Sculptured High Side Eave (Peak)

RP10

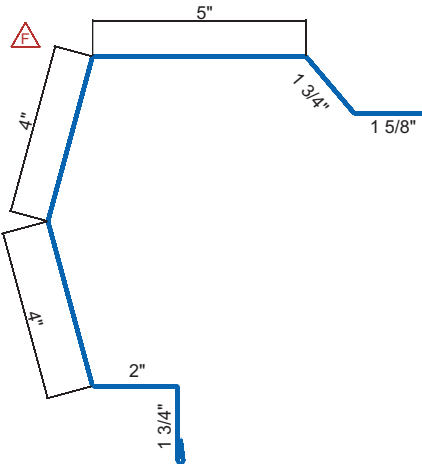

Sculptured Rake Trim

RP11

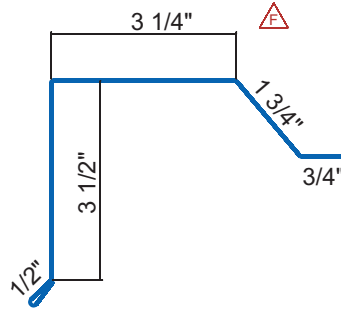

Residential Rake Trim

RP12

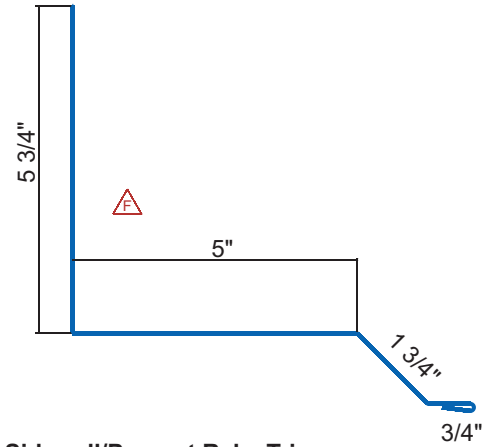

Sidewall/Parapet Rake Trim

RP13

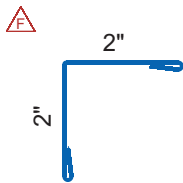

2" x 2" Outside Angle

RP14

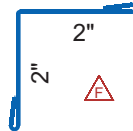

2" x 2" Inside Angle

RP15

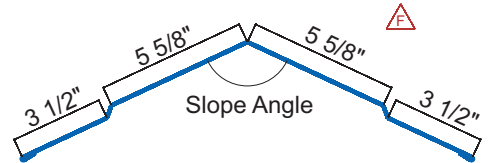

Universal Ridge Cover

RP16

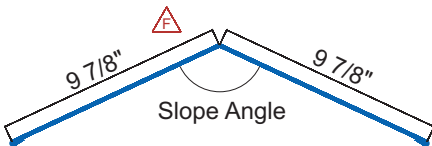

Flat Ridge Cap

RP17

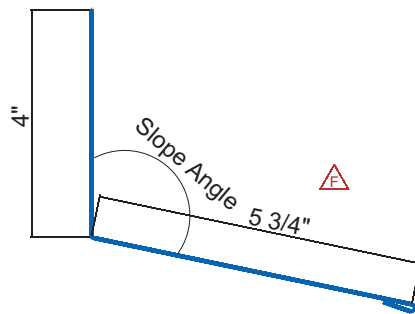

Endwall (Highwall)

RP18

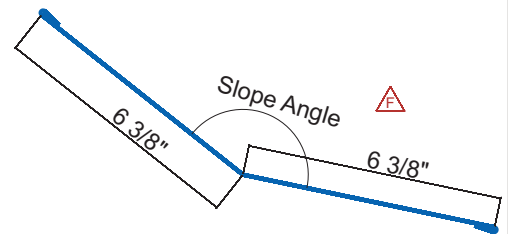

Transition Flashing

PBR/R-Panel Flashings & Trims



RP19

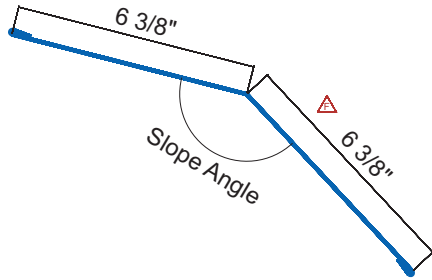

Gambrel Flashing

RP20

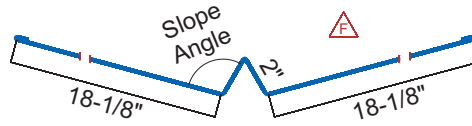

Extended Valley Flashing

RP21

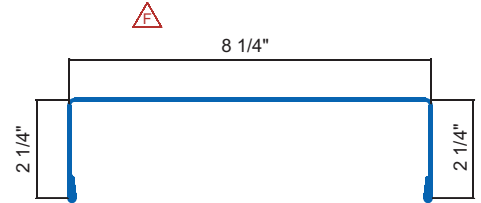

Jamb Cover

RP22

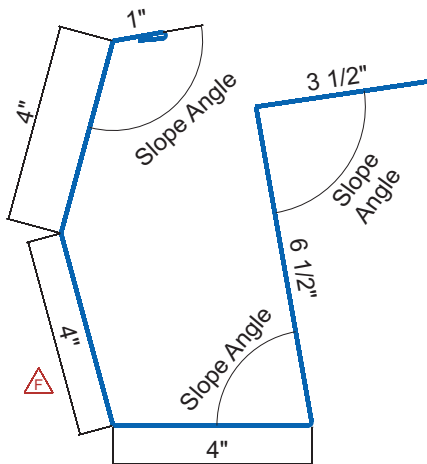

Sculptured Eave Gutter

RP23

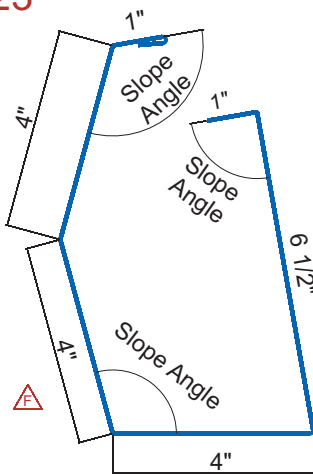

Sculptured Hang-On Gutter

RP24

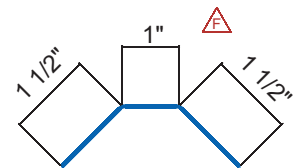

PBR-Panel Gutter Strap
12 inches long

RP25

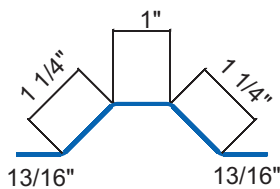

Light Transmitting Panel Trim
Use with polycarbonate skylight panels

DS

'A' x 'B' Dimensions
Part DS34 = 3" x 4"
Part DS35 = 3-1/2" x 4"

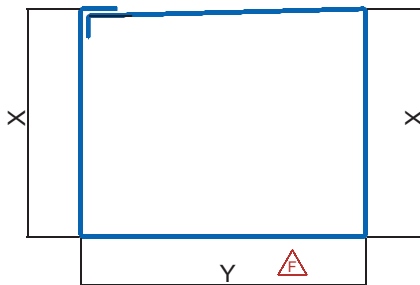

Downspout, Smooth Rectangular

DX01



Downspout Strapping